

PUBLIC GUIDANCE SYSTEMS



CATALOG No. 0206

 **Lavi
Industries**

Products for People and the Places they go®

2 Table of Contents

■ Traditional Posts

PORTABLE TRADITIONAL POSTS	4-5
ROPES AND FINISHES	6
REMOVABLE TRADITIONAL POSTS	7
HOOKS, CHAINS & WALLPLATES	7

■ Beltrac® Public Guidance System

BELTRAC® 3000 SERIES	8-9
BELTRAC CONTEMPO DESIGNER™ SERIES	10
BELTRAC INFINITY ¹² ™ SERIES	11
BELTRAC® 3000 ¹² ™ SERIES	11
BELTRAC CONTEMPO UTILITY™ SERIES	12
EXHIBIT POSTS	13
BELTRAC TEMPEST™ SERIES	14
BELTRAC DOUBLE LINE & RIGID RAILS	15
POST FINISHES	16
BELT COLORS	17
BELTRAC REMOVABLE POSTS	18
BELTRAC OVERVIEW	18
BELTRAC REPLACEMENT PARTS & ACCESSORIES	19
BELTRAC WALL MOUNT UNITS	20
SAFETY BARRIER SOLUTIONS	21
BELTRAC POST & PANEL SYSTEM	22
BELTRAC PRIVACY BOOTHS & SWING GATES	23
POST TRANSPORTER, BAGGAGE SIZER & OUTDOOR BARRICADES	27

■ Signage

RADIUS CORNER SIGN FRAMES	24
TRADITIONAL POST SIGNAGE	25
LIGHT DUTY SIGN FRAMES	26
SIGNAGE INSERTS	26
DIRECTRAC® POST AND CARTRIDGES	28
DIRECTRAC® BASE OPTIONS	29
DIRECTRAC® WALL MOUNT, KIOSK & BACKLIT PANELS	30
POSTER DISPLAY SIGN FRAMES	31
QUICKCLIP™	32

■ NeXtrac™ In-Line Retail System

SYSTEM OVERVIEW	33
HOW IT WORKS	34
RIGID RAILS	35
SURFACES & MERCHANDISERS	36-37
BANNERS & SIGNS	38
FINISHES & SPECIFICATIONS	39

This Public Guidance and Signage catalog is one of three all-inclusive catalogs. Our complete catalog set consists of Public Guidance Systems, Hospitality Fixtures and Railing Components

Lavi Industries was founded in 1979 for the purpose of producing architectural products that meet the highest quality standards for commercial and retail environments. Our superior products are achieved through uncompromised design and manufacturing, using the highest quality materials available. We serve our broad customer base from our corporate headquarters in Valencia, California, our East Coast manufacturing and distribution facilities in Brewster, New York, as well as satellite sales offices in Texas and Illinois.

We have one of the largest on-hand inventories in the industry enabling us to efficiently serve our customers in today's demanding marketplace. We take pride in our outstanding customer service, skilled sales and operations staff who all ensure the satisfaction of our customers.

The products in this catalog are continuously being developed and improved upon. Specifications, data and dimensions may change without notice. When these specifications or colors are critical, consult factory for current information.



Product Innovation



Engineered for



the Real World.

Portable Traditional Posts

Lavi Traditional Posts are classically styled to elegantly guide the public or cordon off a selected area.



**2010
REGAL**

38" Height
12" Base Dia.
31 Pounds

**2020
TRADITIONAL**

38" Height
11" Base Dia.
25 Pounds

**2030
TEMPO**

35" Height
12" Base Dia.
24 Pounds

**2050
MARQUIS**

36" Height
12" Base Dia.
31 Pounds

**2060
CROWN**

41" Height
11" Base Dia.
31 Pounds

**2012
REGAL DUO-TONE**

38" Height
12" Base Dia.
31 Pounds

**2062
CROWN DUO-TONE**

41" Height
11" Base Dia.
31 Pounds

Traditional Post Finishes

	2010	2020	2030	2050	2060	2012	2062
POLISHED STAINLESS	●	●	●		●		
SATIN STAINLESS	●	●	●		●		
POLISHED CHROME	●	●	●	●	●	●	●
LIDO-TONE®		●					
CLEAR COAT POLISHED BRASS	●	●	●	●	●		
POLISHED BRASS	●	●	●	●	●	●	●
DARK BRONZE		●		●	●		

Portable Traditional Posts

All standard posts are factory assembled and include a universal ring that accepts swag ropes from any direction.

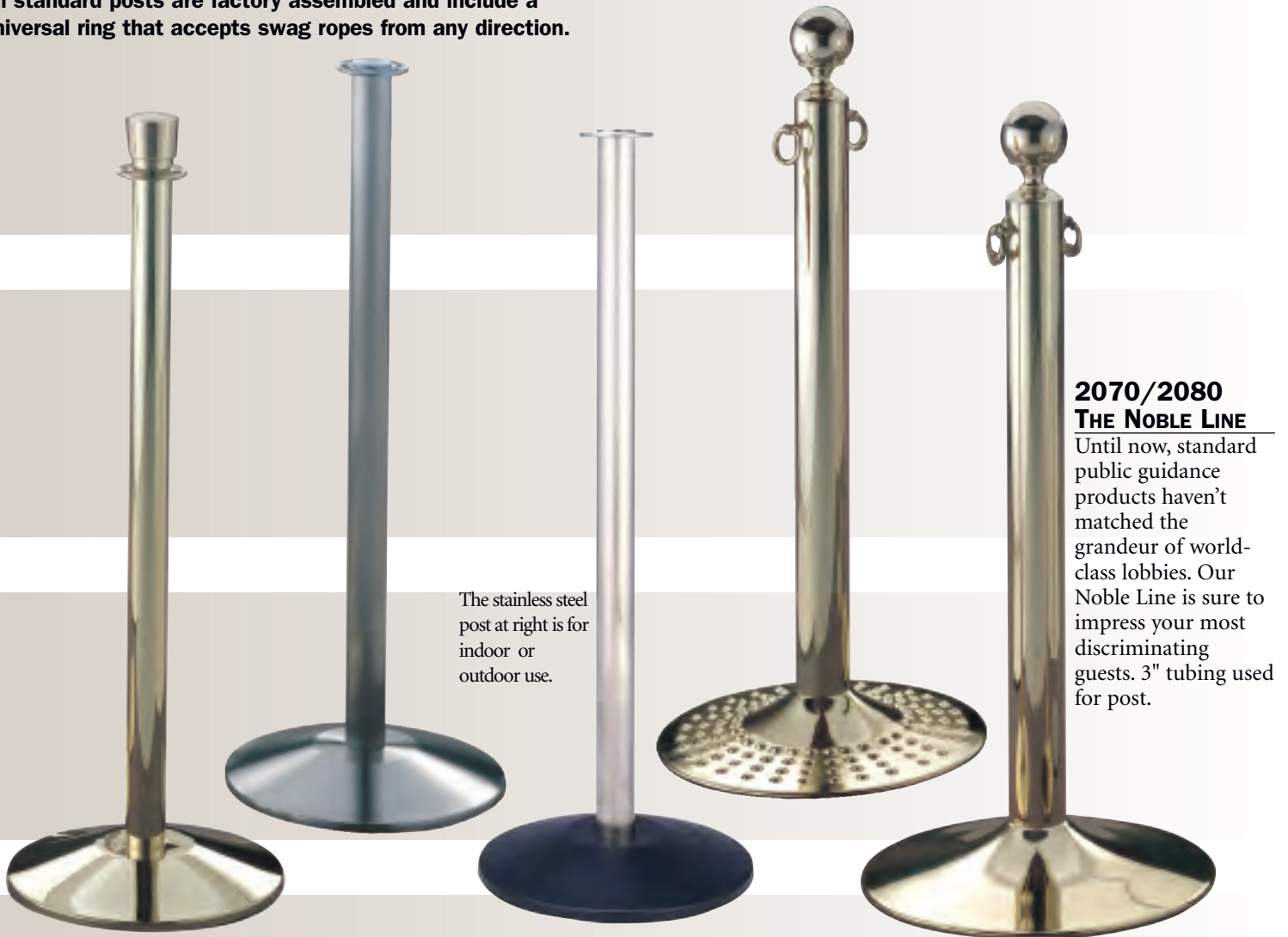

The stainless steel post at right is for indoor or outdoor use.

2070/2080 THE NOBLE LINE

Until now, standard public guidance products haven't matched the grandeur of world-class lobbies. Our Noble Line is sure to impress your most discriminating guests. 3" tubing used for post.

2110 DIRECTOR

41" Height
14" Base Dia.
29 Pounds

2130 CONCOURSE

38" Height
14" Base Dia.
28 Pounds

2131 LEV-GAL

38" Height
14" Base Dia.
24 Pounds

2070 NOBLE I

43" Height
18" Base Dia.
35 Pounds

2080 NOBLE II

43" Height
18" Base Dia.
35 Pounds

Traditional Post Finishes

Removable Posts Page 7

	2110	2130	2131	2070	2080	2016	2036	2136
POLISHED STAINLESS	●	●	●			●	●	●
SATIN STAINLESS	●	●	●			●	●	●
POLISHED CHROME						●	●	
LIDO-TONE®		●				●	●	
CLEAR COAT POLISHED BRASS	●	●		●	●			
POLISHED BRASS	●	●				●	●	
DARK BRONZE								

6 Traditional Posts

Ropes

Ropes are available in rich velour, vinyl, handsome tweed, natural hemp or braided nylon.



Braided & Tweed Ropes

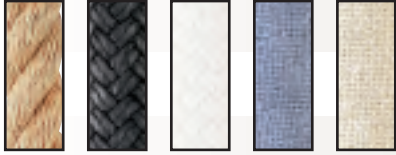

Natural Hemp (N) Black Braided (BK) White Braided (WH) Azure Tweed (AZ) Natural Tweed (N)

Velour Ropes



Evergreen (EG) Black (BK) Silver (SV) Antique (AN) Cardinal (CD) Crimson (CR) Cambridge (CB) Tobacco (TB)

Vinyl Ropes



Snow (SN) Gray (GY) Black (BK) Gold (GD) Red (RD) Moss Green (MG) Wine (WN) Indigo (IN)

Metal Finishes

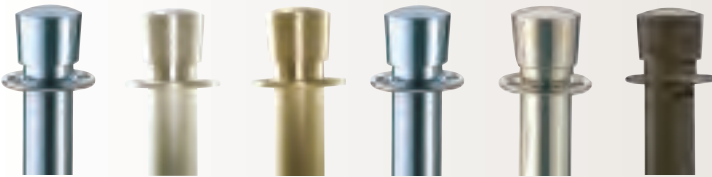

Polished Stainless Steel (40) Satin Stainless Steel (44) Satin Brass (04) Polished Chrome (10) Polished Brass (00) Dark Bronze (07)

FINISH SPECIFICATIONS

When ordering posts please precede model number with finish designation.:

- 00 Polished Brass
- 02 Polished Brass, Clear Coated
- 04 Satin Brass
- 07 Dark Bronze
- 10 Polished Chrome
- 26 Lido-Tone®
- 40 Polished Stainless Steel
- 44 Satin Stainless Steel

Lido-Tone® Wet-Look Finishes



Statuary Bronze (SB) Torch Red (TR) Sea Green (SG) Wheel White (WW) Gloss Black (GB) Utility Gray (UG) Blue (BL) Hunter Green (HG) Sandstone (SS) Silver Matte (SM)

Lido-Tone® Textured Finishes



Wrinkle Black (WB) Wrinkle Charcoal (WC) Verdi Gris (VG) Pacific Sand (PS)

Traditional Removable Posts and Floor Sockets

Our line of Removable Posts has three distinctive styles. The Regal and Tempo Posts accept swag ropes and the Tempo II accepts $\frac{3}{4}$ " rope for a continuous loop-through design.

Posts may also be permanently installed. See Page 18, option B.

Please refer to the table on page 5 for available finishes.

**2016
REGAL
REMOVABLE**
38" Height



**2036
TEMPO
REMOVABLE**
36" Height

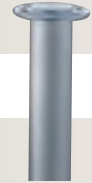

**2136
TEMPO II
REMOVABLE**
36" Height



**544/2
FLOOR SOCKET WITH CAP**

The Floor Socket supports a removable post. When the post is not in use, the flush cap seals the socket.

Dimensions D – $2\frac{7}{8}$ ", H – $4\frac{1}{2}$ "
Flange lip is $\frac{1}{4}$ ".

- Finishes -
Polished Stainless Steel (40)
Satin Stainless Steel (44)

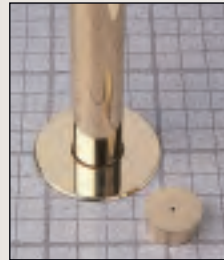

**545/2
FLOOR SOCKET WITH CAP**

Similar to the above 544/2.

Dimensions D – 5", H – $4\frac{1}{2}$ "
Flange lip is $1\frac{1}{2}$ ".

- Finishes -
Polished Brass (00)
Polished Stainless Steel (40)
Satin Stainless Steel (44)

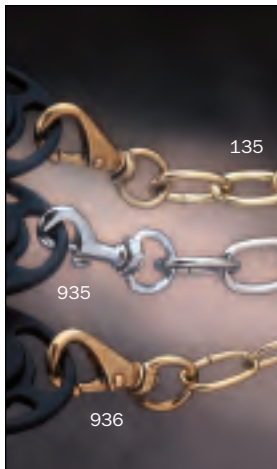
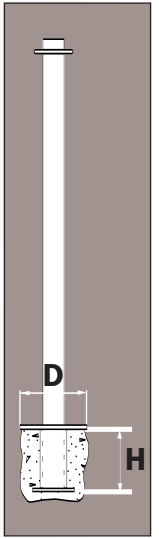

**135
No. 4
HEAVY CHAIN**
Stainless Steel/ Chrome/ Brass

**935
CHAIN SNAP**
Stainless Steel/ Brass

**936
NAUTICAL
CHAIN SNAP**
Brass

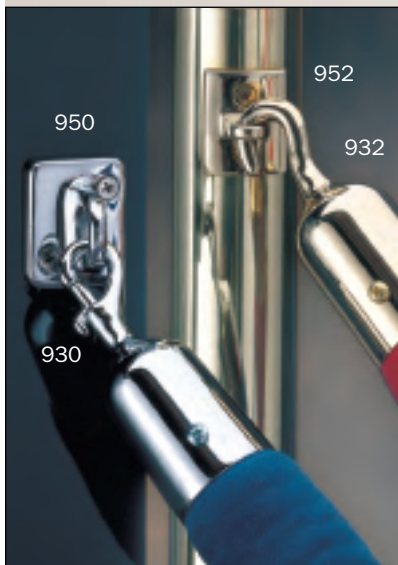

**950
WALL PLATE**
Stainless Steel/ Brass

**952/1H
RADIUS PLATE – $1\frac{1}{2}$ " TUBING**
Stainless Steel / Brass

**952/2
RADIUS PLATE – 2" TUBING**
Stainless Steel / Brass

**930
 $1\frac{1}{2}$ " SNAP ROPE HOOK**
Stainless Steel/ Brass

**931
1" SNAP ROPE HOOK**
Chrome/ Brass

**932
 $1\frac{1}{2}$ " ROPE HOOK**
Stainless Steel / Brass

Chains, Hooks & Wall Plates



Beltrac® 3000 Posts

Innovation. Safety. Choice. Value.
Built into every Beltrac® product.

- **Structural Integrity**
 The Beltrac post is constructed of a continuous extrusion attached to a weighted steel base.
- **4-way Connection**
 Each Beltrac post is equipped with an imbedded 4-way post-to-post connection.
- **Slow Retraction**
 All Beltrac posts feature a unique belt retraction braking system.
- **Rubberized Base**
 To protect flooring, all bases come with a standard non-marking rubberized bottom.
- **Assembly**
 Every Beltrac post can be factory assembled or shipped unassembled. On site assembly is made easy with a simple twist of a key (included). Connection assembly is Patent pending.



SLOW RETRACT MECHANISM

Beltrac's belt retracts slowly and safely every time thanks to our unique centrifugal belt-braking mechanism.

All Beltrac posts are designed and built in the U.S.A.

921 LITERATURE HOLDER

Puts your 4" wide pamphlets right in line with your customers. Easily attaches to any Beltrac post groove without fasteners.

BELTRAC® 3000 POST DIMENSIONS

Height	40"
Weight	28 lbs
Base	14"
Belt Length	7'



50-3000GD Beltrac® 3000
 Shown in Gold.



50-3000WB Beltrac® 3000
 Shown in Wrinkle Black.

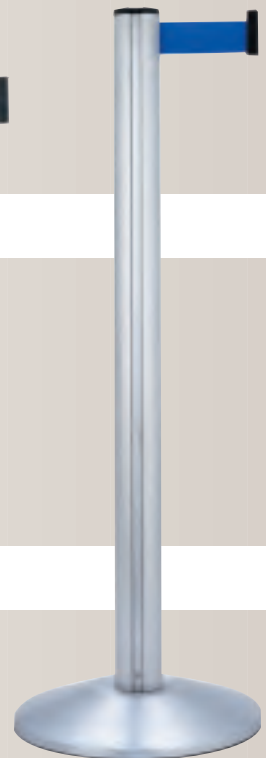

50-3000SA Beltrac® 3000
 Shown in Satin Aluminum.

50-3000CL Beltrac® 3000

Shown in Polished Chrome.

Patent No. D343690

Beltrac® 3000 Posts



4-WAY RECEPTACLE

Beltrac's patented integral "dove tail" receptacles make every post a standard 4-way intersection.



910LK BELTLOC™

Beltrac's exclusive Beltloc option is a fully automatic metal locking system that prevents accidental release of belts. Beltloc™ will also securely lock signs in place.



3011 WALL RECEPTACLE

Post-to-wall configurations are possible with the installation of our wall receptacle.



RMECH7 REPLACEMENT MECHANISM

Beltrac's mechanism is easy to replace and allows you to change belt colors or messages without changing the entire post.



50-3000BZ
Beltrac® 3000
Shown in Bronze.

50-3000CH
Beltrac® 3000
Shown in Champagne.

50-3000TR
Beltrac® 3000
Shown in Torch Red.

For a complete listing of Beltrac® 3000 finishes, please see Page 16. Please see belt colors and options on Page 17.



Beltrac Contempo Designer™

The Contempo Designer models are manufactured from either the highest quality solid brass or solid steel. Our full range of Lido-Tone® finishes, belt options and a choice of 2 base diameters affords you total design freedom!

Contempo Designer™ Finishes

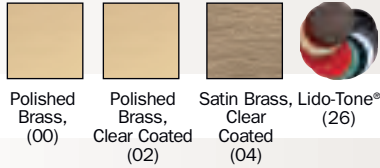

Polished Brass, (00) Polished Brass, Clear Coated (02) Satin Brass, Lido-Tone® Clear Coated (04) Lido-Tone® (26)

Please precede model number with finish designation. Example: 02-40701 Polished Brass, clear coated Contempo Designer with 12.5" Base.

For a complete listing of Lido-Tone® colors, please see Page 16. Please see belt colors and options on Page 17.

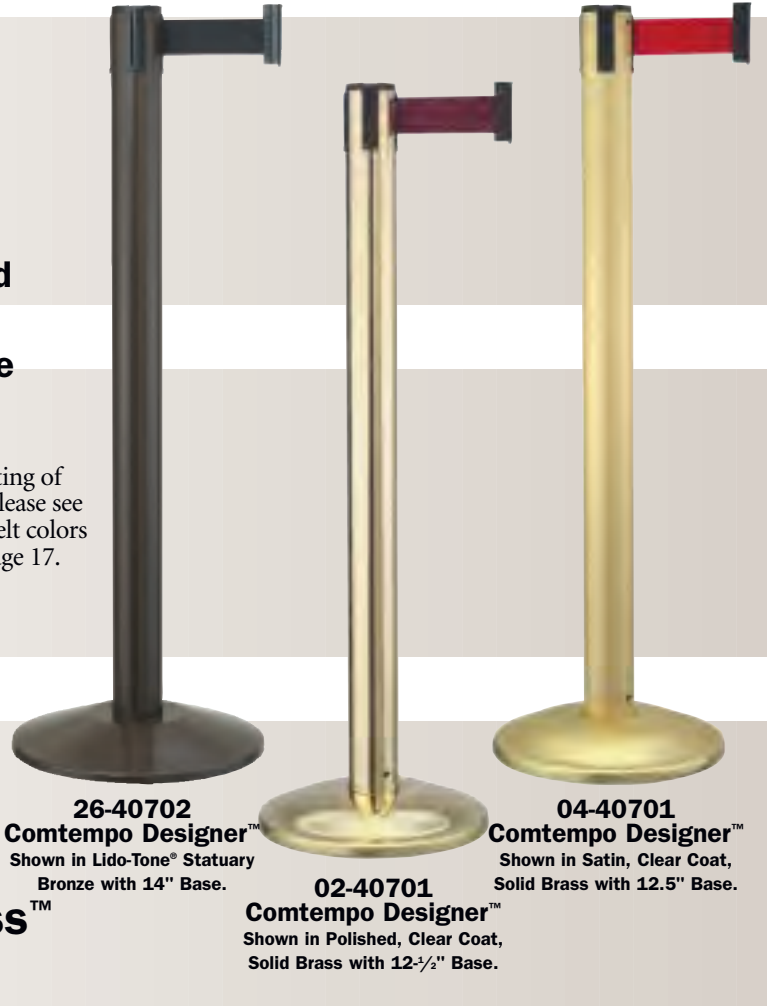

26-40702
Contempo Designer™
Shown in Lido-Tone® Statuary Bronze with 14" Base.

02-40701
Contempo Designer™
Shown in Polished, Clear Coat, Solid Brass with 12-1/2" Base.

04-40701
Contempo Designer™
Shown in Satin, Clear Coat, Solid Brass with 12.5" Base.

Beltrac Contempo Stainless™

Beltrac Contempo Stainless™ is built for elegance and durability. Manufactured from solid stainless steel, the standard features include a 14" base and the Beltloc™ belt and sign locking mechanism. The Contempo Stainless can be used in outdoor applications.

Contempo Stainless™ Finishes



Polished Stainless Steel (40) Satin Stainless Steel (44)

CONTEMPO DESIGNER™/CONTEMPO STAINLESS™ POST DIMENSIONS

Height	40"
Weight	30 lbs
Base	12-1/2" and 14"
Belt Length	7'



40-40702
Contempo Stainless™
Shown in Polished Stainless Steel with 14" Base.

Patent No. D343690

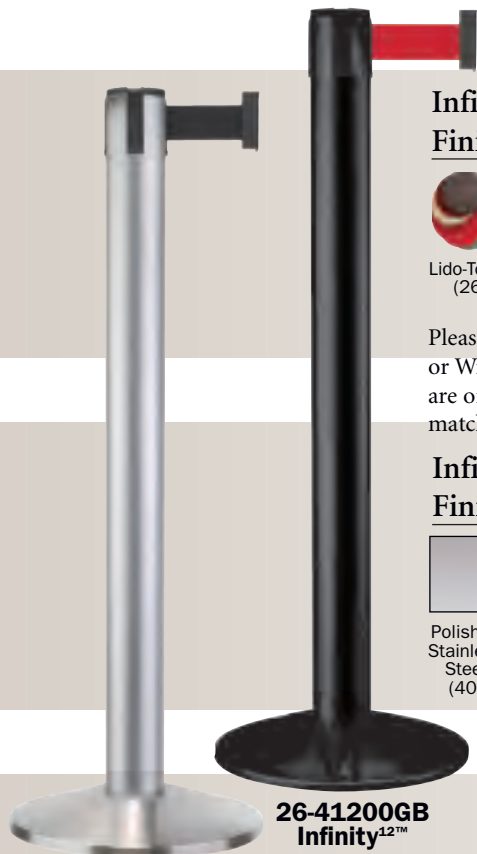

Infinity^{12™} Finishes



Lido-Tone® (26)

For a complete listing of Lido-Tone® colors, please see Page 16. Please see belt colors and options on Page 17.

Please Note: If Wrinkle Black (WB) or Wrinkle Charcoal (WC) finishes are ordered, base covers will be color matched heavy duty plastic.

Infinity^{12S™} Finishes



Polished Stainless Steel (40)



Satin Stainless Steel (44)

44-41200 Infinity^{12S™}

Shown in Satin, Stainless Steel with 14" Base.

26-41200GB Infinity^{12™}

Shown in Lido-Tone® Gloss Black with 14" Base.



Beltrac® 3000¹² Finishes



Satin Aluminum (SA)



Lido-Tone® (26)

50-3100SA Beltrac® 3000¹²

Shown in Satin Aluminum with 14" Base.

50-3100WB Beltrac® 3000¹²

Shown in Lido-Tone® Wrinkle Black with 14" Base.

Beltrac Infinity^{12™}

The Beltrac Infinity^{12™} posts are built for strength and distance. The 12' belts connect to all Beltrac models. Each post is constructed of one continuous solid steel post attached to a specially weighted base.

Beltrac Infinity^{12S™}

The "S" in Infinity^{12S™}, stands for stainless steel. With this model you receive all of the same great features as our Beltrac Contempo Stainless™, only with a 12' belt.

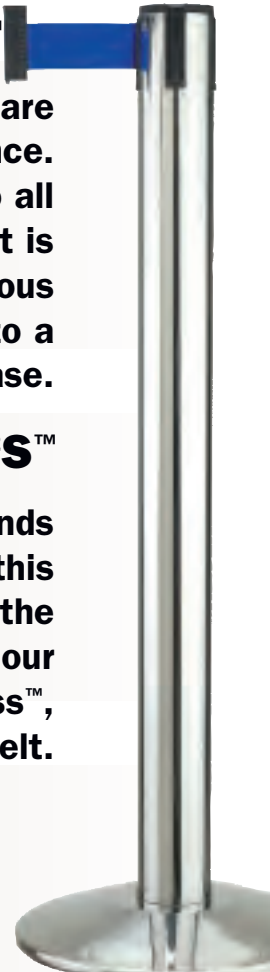

40-41200 Infinity^{12S™}

Shown in Polished Stainless Steel with 14" Base.

INFINITY^{12™} / INFINITY^{12S™} / BELTRAC 3000¹²

POST DIMENSIONS

Height	40"
Infinity Weight	32 lbs
3000 ¹² Weight	30 lbs
Base	14"
Belt Length	12'

Beltrac® 3000¹²

Lavi Industries proudly offers our classic Beltrac post with a 12' belt. The Beltrac 12' version easily attaches to any standard Beltrac 7' post you may already have. We offer this 12' version with single or double line retractable belts.

50-912FM

Please note that signage for all our 12' posts work only with fixed sign frame bracket 50-912FM. (See page 24 and 26 for post signage.)



Beltrac Contempo Utility™

Exceptional value with Lavi reliability.

Contempo Utility™ posts are available in three selected finishes and belt colors indicated on this page. Combined with efficient shipping and storage, you have an economical solution without sacrifice of quality.

Contempo Utility™ Finishes

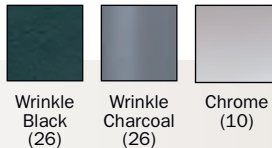

Wrinkle Black (26)

Wrinkle Charcoal (26)

Chrome (10)

Please precede model number with finish designation.
Example: 10-40700 Polished Chrome Contempo Utility with 12.5" Wrinkle Charcoal Base.

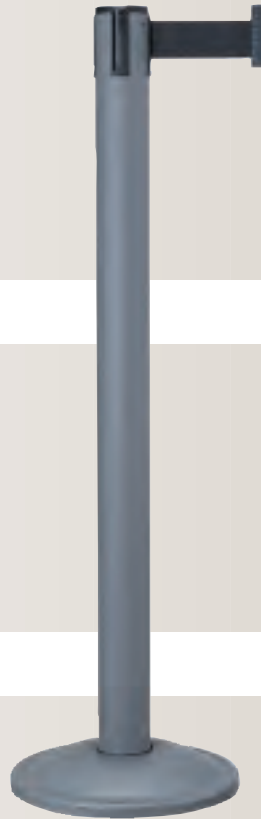

26-40700WC Contempo Utility™
Shown in Lido-Tone® Wrinkle Charcoal with 12-½" Base.



26-40700WB Contempo Utility™
Shown in Lido-Tone® Wrinkle Black with 12-½" Base.

Contempo Utility™ Belt Colors

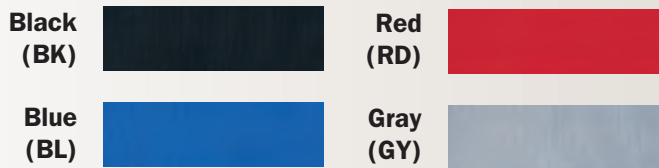

Black (BK)

Red (RD)

Blue (BL)

Gray (GY)

CONTEMPO UTILITY™ POST DIMENSIONS	
Height	40"
Weight	30 lbs
Base	12-½"
Belt Length	7'

Cut the high cost of freight!

Posts and bases are shipped unassembled. The post is securely assembled with an easy twist of a key (included). This option is available for all Beltrac Posts. Patent pending.



10-40700 Contempo Utility™

Shown in Polished Chrome with 12.5" Wrinkle Charcoal Base.



Exhibit Posts

Our 24" exhibits posts are ideal for safeguarding exhibits by establishing a visual perimeter and allowing an unobstructed view.

All posts are available in a variety of styles and finishes.



Regal Exhibit Finishes

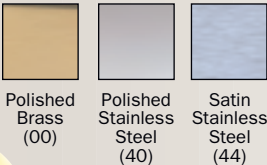

See Page 6 for rope color options.

00-2010/24 Regal Exhibit
Shown in Polished Brass.

24" Height
12" Base Dia.
26 Pounds

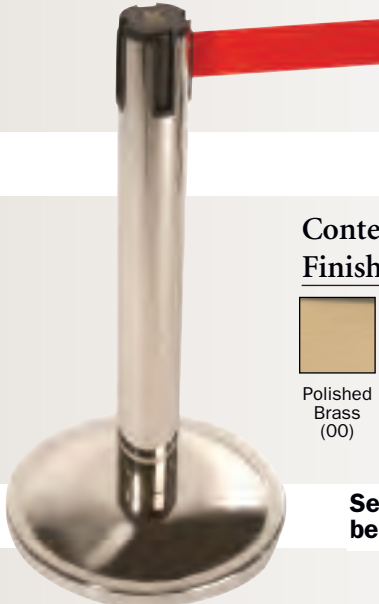

Contempo Designer™ Exhibit Finishes



See Page 17 for retractable belt color options.

40-407024 Contempo Designer™ Exhibit
Shown in Polished Stainless Steel.

24" Height
12-1/2" Base Dia.
27 Pounds

Beltrac Tempest™

Weatherproof.

The Beltrac Tempest™ is a single connection post featuring a 12' slow retracting belt and is constructed of weatherproof HDPE plastic; High Density PolyEthylene. The posts are designed for quick assembly on site allowing for easy transport and storage.

BELTRAC TEMPEST™ POST DIMENSIONS	
Height	38-1/4"
Weight (empty)	3.98 lbs
Weight (fill w/liquid)	17.55 lbs
Base	15"
Belt Length	12'

**80-5000BK1
Beltrac Tempest™**
Shown in Black Post
with Gray Base.

**80-5000BK
Beltrac Tempest™**
Shown in Black Post
with Black Base.

Beltrac Tempest™ Post Color Options Base Color Options



Orange
(OR)



Black
(BK)



Black
(BK)



Gray
(GY)

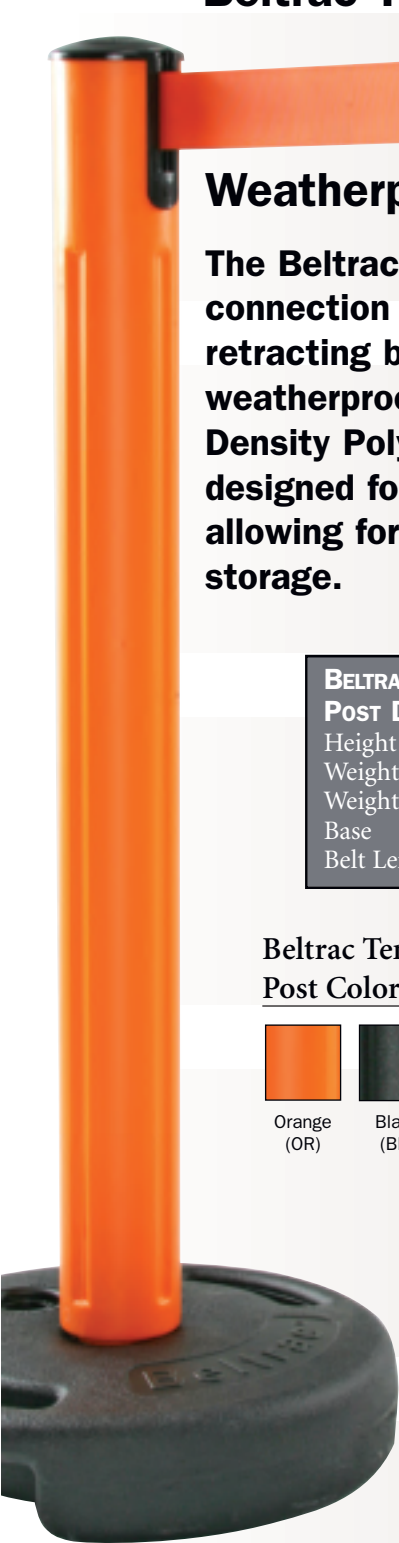

**80-5000OR
Beltrac Tempest™**
Shown in Orange Post
with Black Base.

Warranty - one year for post and mechanism.



The hollow base is filled with liquid or sand.



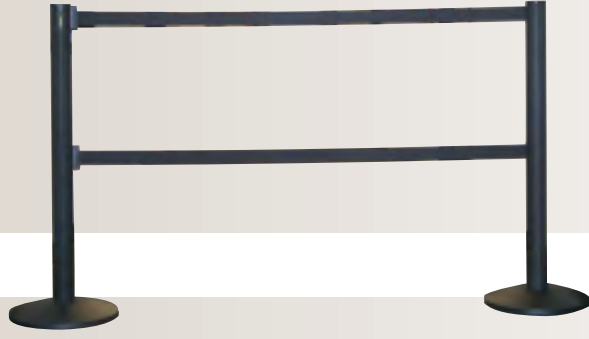

Beltrac Double Line

Beltrac Double Line offers the same benefits as the Beltrac® 3000, only with two 7' belts.

The lower belt extends at 22" from the floor.

We also offer the Beltrac 3100 Double Line with two 12' belts.

BELTRAC® 3000 DOUBLE LINE POST DIMENSIONS	
Height	40"
Weight	30 lbs
Base	14"
Belt Length	7'

50-3000DL/WB
Beltrac® 3000
 Shown in Lido-Tone®
 Wrinkle Black.

Beltrac Rigid Rails

Rigid rails provide a more structural option for your public guidance needs.

The Rails are supplied with our Adjustable Hinge Connectors and attach to any Beltrac Post. The special method of attachment, allows you to adjust the rail to any desired height.

For a complete Rigid Rail product listing, please see page 35.



Beltrac® Rigid Rail Finishes



Satin Aluminum (C)

Matte Black (MB)

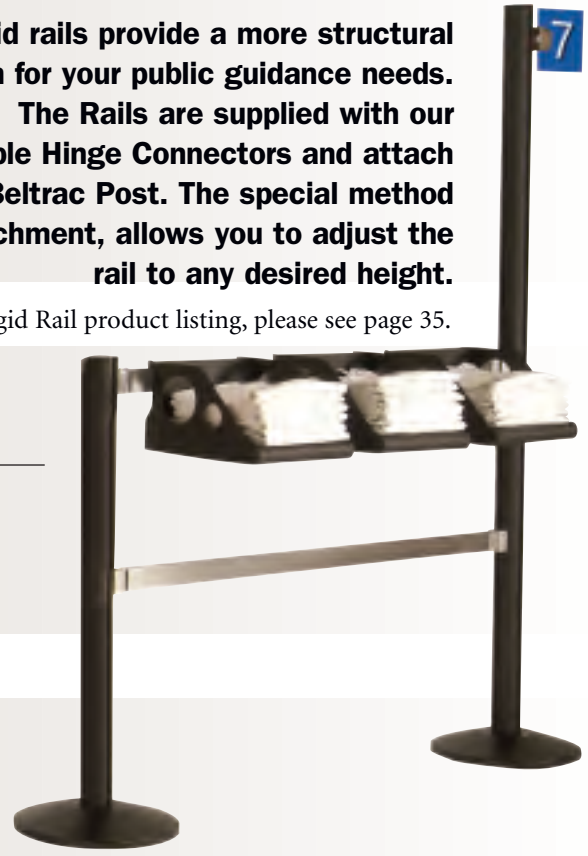

50-CRA100/4
CURVED RIGID RAIL

Available in 4' lengths and includes 2 hinge grip connectors. Post and accessories sold separately.

50-RRA100/3, /4, OR /6
RIGID RAIL ASSEMBLY

Available in 3', 4' and 6' lengths and includes 1 rail and 2 hinge connectors. Posts and accessories sold separately.

Beltrac Finishes

Anodized Metal Finishes for Beltrac® 3000 Series Posts



Chrome
(CL)



Satin Aluminum
(SA)



Champagne
(CH)

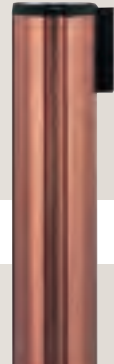

Bronze
(BZ)



Gold
(GD)

Lido-Tone® Texture



Wrinkle
Black
(WB)



Wrinkle
Charcoal
(WC)



Verdi Gris
(VG)



Pacific
Sand
(PS)

Lido-Tone® Wet Look



Blue
(BL)



Hunter
Green
(HG)



Sandstone
(SS)

Lido-Tone® Wet Look



Gloss Black
(GB)



Statuary
Bronze
(SB)



Torch Red
(TR)



Sea Green
(SG)



Wheel
White
(WW)

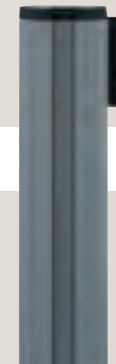

Utility
Gray
(UG)



Silver
Matte
(SM)

Please refer to Page 18 to match your choice model with available finish.

Beltrac Belts



Our Beltrac belts are available in a wide variety of belt colors. Our in-house belt imaging department can display your logo and/or message to reinforce your company identity based on the EPS digital illustration artwork you supply to us.

Belt Colors

Red Series

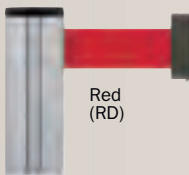

Neutral Series

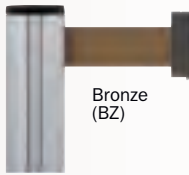
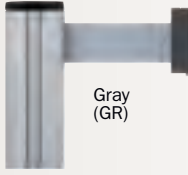
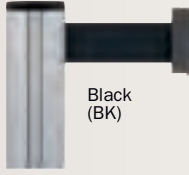

Blue Series

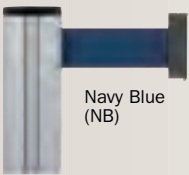

Caution Series

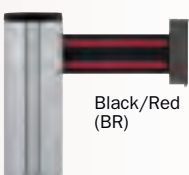
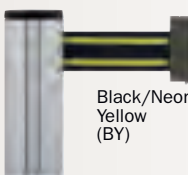
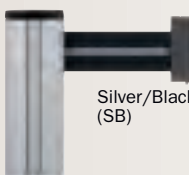

Green Series

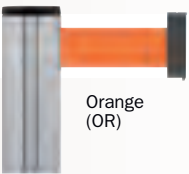
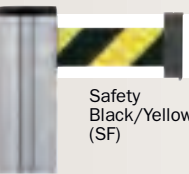
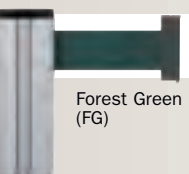

STANDARD SAFETY MESSAGES

Caution • Please Do Not Enter

Please Do Not Enter • Temporarily Closed

Permanent/Removable Post Options

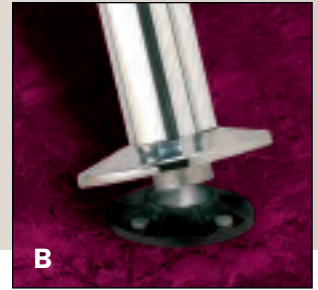
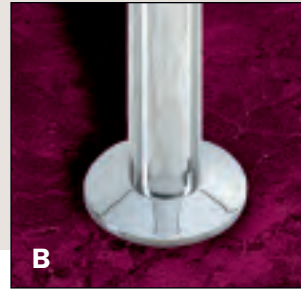
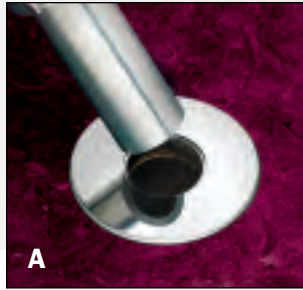
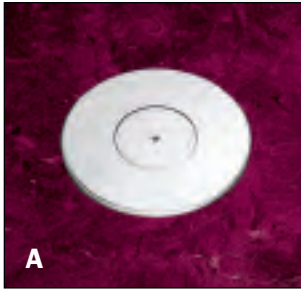

REMOVABLE (A)

The Floor Socket supports a removable post. When the post is not in use, the flush cap seals the socket opening. This option is available for all Beltrac 7ft posts and traditional posts.
 5-³/₁₆" Dia. x 4-¹¹/₁₆" Depth (Custom depth available)

PERMANENT (B)

Post can be permanently secured by using a surface mounted flange. This option is available for all Beltrac 7ft posts and traditional posts (541/2) and decorative canopy (540BT).
 4" Dia. x ⁵/₈" H

Beltrac Product Line Overview

	3000	Contempo Utility™	Contempo Designer™	Contempo Stainless™	Infinity ¹² ™	Infinity ¹² S™	Beltrac 3000 ¹²	Beltrac Tempest™
Post Height	40 inch	40 inch	40 inch	40 inch	40 inch	40 inch	40 inch	38 inch
Weight	28 lbs	30 lbs	30 lbs	30 lbs	32 lbs	32 lbs	30 lbs	17.55 lbs
Post Construction	Aluminum	Steel	Steel, Brass	Stainless Steel	Steel	Stainless Steel	Aluminum	HDPE Plastic
Finish (Page 16)	Anodized Lido-Tone®	Wrinkle Black, Chrome Wrinkle Charcoal	Brass, Lido-Tone®	Polished Stainless Steel Satin Stainless Steel	Lido-Tone®	Polished Stainless Steel Satin Stainless Steel	Satin Anodized, Lido-Tone®	HDPE Plastic
Base Cover	Metal or Plastic	Powder Coat Over Base	Metal or Plastic (14")	Stainless Steel	Metal or Plastic	Stainless Steel	Metal or Plastic	None
Slow Retracting Belt	Yes	Yes	Yes	Yes	Yes	Yes	Yes	Yes
Belt Length	7 ft	7 ft	7 ft	7 ft	12 ft	12 ft	12 ft	12 ft
Beltloc™	Option	Option	Option	Yes	Option	Yes	Option	No
4-way Belt Connection	Yes	Yes	Yes	Yes	Yes	Yes	Yes	No
Base Diameter	14 inch	12.5 inch	12.5 or 14 inch	14 inch	14 inch	14 inch	14 inch	15 inch
Rubberized Base	Yes	Yes	Yes	Yes	Yes	Yes	Yes	No
Signage Ready	Yes	Yes	Yes	Yes	Yes	Yes	Yes	No
Outdoor Usage	Option	No	No	Option	No	Option	Option	Yes
Warranty	5 yr / Post 3 yr / Mechanism	5 yr / Post 3 yr / Mechanism	5 yr / Post 3 yr / Mechanism	5 yr / Post 3 yr / Mechanism	5 yr / Post 3 yr / Mechanism	5 yr / Post 3 yr / Mechanism	5 yr / Post 3 yr / Mechanism	1 yr / Post 1 yr / Mechanism

Beltrac Replacement Parts and Accessories

Lavi Industries offers a complete line of replacement parts to prolong and enhance the life of your Beltra[®] products and accessories.



BELTLOC™
80-910LK
 7' Beltloc™ Kit
80-912LK
 12' Beltloc™ Kit



80-910BE10
BELT END ASSEMBLY
 10-Pack



80-910/WBM
COVER PLATE
 Available in Wrinkle Black.



26-911SW
METAL SWIVEL SIGN BRACKET
 Available only for 7' posts



50-911FM
 Metal Fixed Mount Sign Bracket for 7'

50-912FM
 Metal Fixed Mount Sign Bracket for 12'

Great for changing belt colors or silk-screened messages!



REPLACEMENT MECHANISM

RMECH7/XX
 7' Beltrac® 3000/ Contempo

RMECH12/XX
 12' Infinity¹² / Beltrac® 3000¹²



REPLACEMENT MECHANISM WITH BELTLOC™

RMECH7/XX/LK
 7' Beltrac® 3000/ Contempo

RMECH/XX/LK
 12' Infinity¹² / Beltrac® 3000¹²

Please Note: XX represents the belt color. Please see page 17, for belts colors.



921
LITERATURE HOLDER
 Puts your 4" wide pamphlets right in line with your customers. Easily attaches to any Beltrac post groove without fasteners.



3011
WALL RECEPTACLE
 Post-to-wall configurations are possible with the installation of our wall receptacle.

Beltrac Wall Mount Units

Our line of Beltrac wall mounted solutions offer more options for security and guidance. Best suited to section off aisles, corridors and cash registers.



3010 BELTRAC WALL MOUNT UNIT

The compact Beltrac Wall Mount can be used to close off cash register stations and eliminate dangling chains and signs. 7 ft. belt span. Available in all Beltrac® 3000 7 ft. series finishes and belt colors, please see page 16.

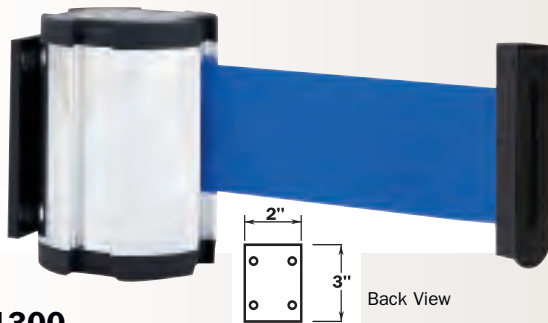

3011 WALL RECEPTACLE

Post-to-wall configurations are possible with the installation of our wall receptacle.



41300 BELTRAC 12' WALL MOUNT UNIT

This Beltrac Wall Mount has a slightly larger in diameter to house a 12 ft. belt then our 7 ft. model. This unit is long enough to block off an entire store section or department area. Available in Satin Aluminum (SA) and Lido-Tone®(26) Finishes. Please see page 16.

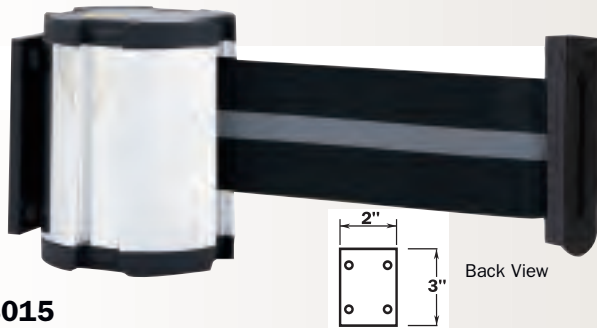

41300WB/CM BELTRAC COUNTERMOUNT UNIT

This compact 12 ft. retractable Countermount unit includes a double-sided "Lane Closed" message.



3015 BELTRAC 18' WALL MOUNT

18 ft. Beltrac Wall Mount is ideal for closing off wide corridors. Housing available in polished chrome or Lido-Tone® colors. Belt available in all belt colors.



3012 BELTRAC RECESSED WALL UNIT

Mechanism is concealed within the wall with only a flush Satin Aluminum face plate exposed. 7 ft. belt.

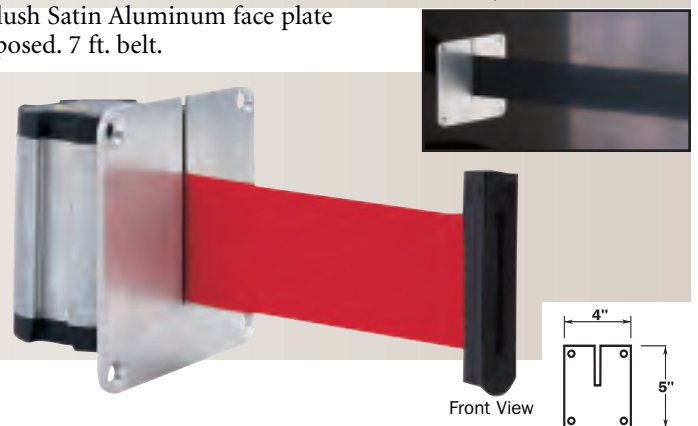

Patent No. D343690

QuickMount™ Safety Barrier Solutions



Ideal for improving safety in a warehouse or similar environment, we developed a temporary closure solution... a full line of products that ensure an effective “safety zone” wherever it’s needed.

STANDARD SAFETY MESSAGES

Caution • Please Do Not Enter

Please Do Not Enter • Temporarily Closed

3016M 18' QUICKMOUNT™

Designed for temporary mounting conditions, such as warehouse shelving or trailer attachment, available with a 18' belt span. Housing available in Safety Yellow or Wrinkle Black.

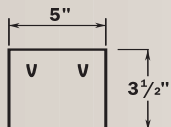
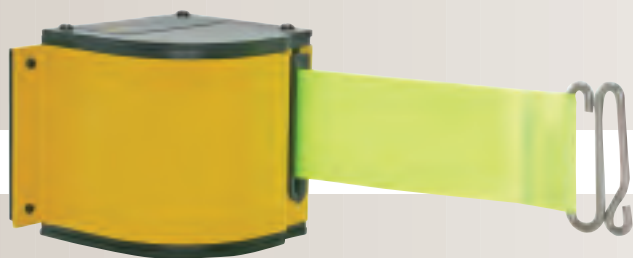

Back View
Teeth easily mount to slotted upright.



3017 18' FIXEDMOUNT

Same unique system as QuickMount, but for a permanent attachment, available with a 18' belt span Housing available in Safety Yellow or Wrinkle Black.



Top View

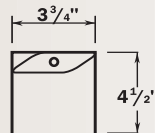

Back View
Bolts used to permanently mount unit to slotted upright.



I-Beam or Rack Upright

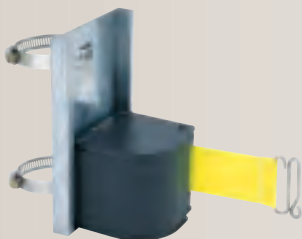

20-917/FM FORKLIFT MOUNT

For convenient attachment to forklifts. (WallMount not included.)

40-915TM/SET TRAILER MOUNT

Allows fast and easy mounting of QuickMount™ to trailers. (QuickMount™ not included.)



Post and Panel System



Our flexible hinge connector allows for a full range of positions.



POST AND PANEL SYSTEM

The Post and Panel system works effortlessly with our Beltrac posts. Advertisements, company logos and other messaging may be prominently displayed while effectively directing customer flow. The panels are clear or colored acrylic suitable for posters, opaque barriers or messages.

Frame Specifications:

Finish: Satin Aluminum (SA), Wrinkle Black (WB)

Panel Specifications:

Thickness: 1/4" standard

Color: Black, white, gray, smoked acrylic, clear acrylic (2 pieces 1/8" for posters)



As Shown: Clear panels with poster insert. Custom Finishes available.

Post and Panel usage instructions are available on line at www.lavi.com.

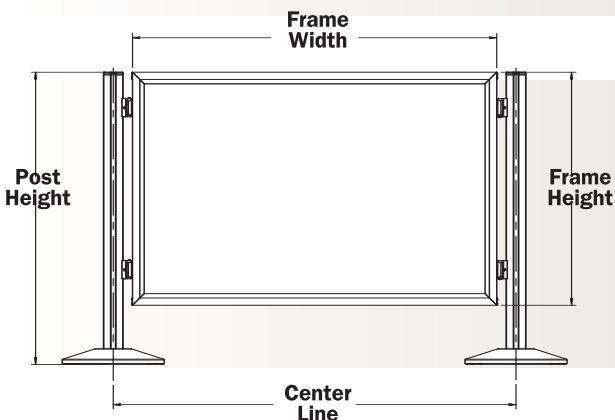

PART NO.	POST HEIGHT	FRAME HEIGHT	FRAME WIDTH	CENTER LINE	INSERT DIMS
FP300S/4	40"	32"	50"	55- ⁵ / ₁₆ "	30"H x 48"W
FP300S/5	40"	32"	62"	67- ⁵ / ₁₆ "	30"H x 60"W
FP300S/6	40"	32"	74"	79- ⁵ / ₁₆ "	30"H x 72"W
FP300TS/4	66" or 72"	50"	50"	55- ⁵ / ₁₆ "	48"H x 48"W
FP300TS/5	66" or 72"	50"	62"	67- ⁵ / ₁₆ "	48"H x 60"W
FP300TS/6	66" or 72"	50"	74"	79- ⁵ / ₁₆ "	48"H x 72"W

Lavi Industries' Privacy Booths are designed to give you maximum privacy in a variety of settings. One of the most popular settings is at airports. These "portable rooms" are made from our Beltrac posts and come in opaque fabric. The "Rip-Stop Nylon" material is rip resistant, fire retardant and comes in matte black. Privacy Booths are easy to maneuver from one location to another depending on your security needs.

Beltrac Privacy Booths

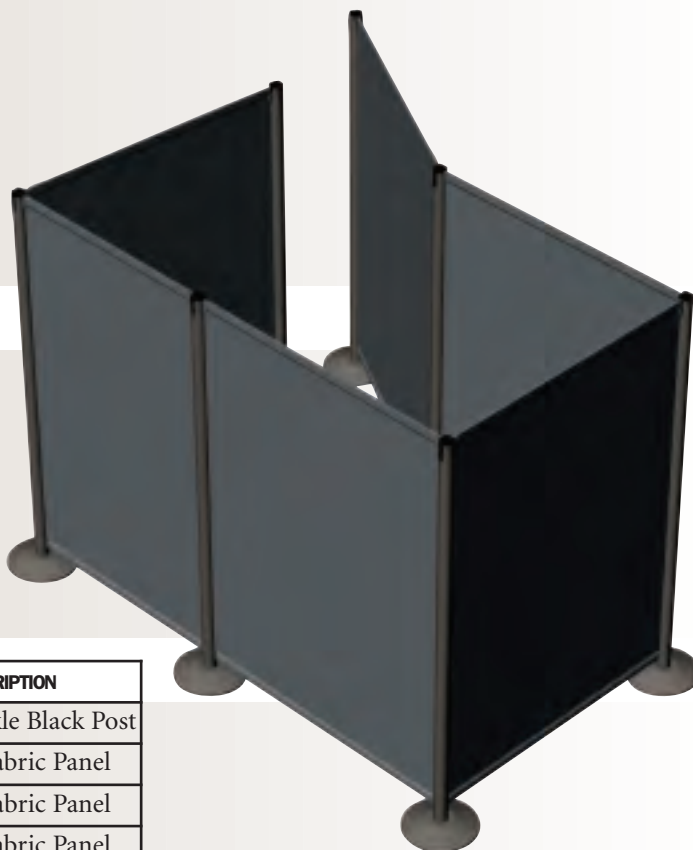

PART NUMBER	DESCRIPTION
26-PB175	7' Wrinkle Black Post
60-PB300	3' x 7' Fabric Panel
60-PB301	4' x 7' Fabric Panel
60-PB302	5' x 7' Fabric Panel



Beltrac Swing Gates

In a world where security is a top concern, Lavi has developed portable swinging gates that visually alert and block the public from potentially unsafe or restricted areas. The spring loaded gate is easily attached to any Beltrac® post to create an instant access gate in a matter of minutes.

PART NUMBER	DESCRIPTION
3000GATE/1L	Left Swinging Gate
3000GATE/1R	Right Swinging Gate
3000GATE/2	Double Swinging Gates



Back View

The gate panels are constructed from black durable plastic coated foam board and can be silkscreened with messages on both sides.

Radius Corner Sign Frames



Our sign frames feature smooth radius corners that eliminate sharp edges near your customers.



Sign frame ordering is as easy as 1 - 2 - 3

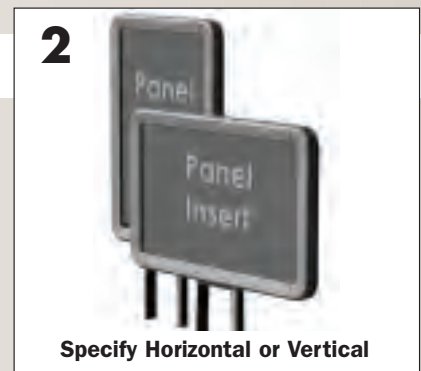
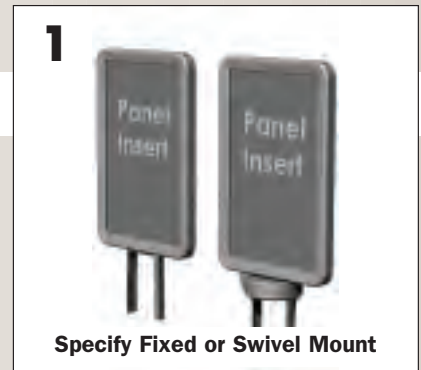

1111SW
Sign Clip on 8-way swivel bracket. (Graphics and acrylics are sold separately.)

Lavi Industries offers a wide variety of sign frame sizes and options. All of our frames, in combination with Beltrac's exclusive Beltloc™ option, provide tamperproof signage. Two clear acrylic panels are included with the frame. Our 22" x 28" sign frame is the strongest frame this size in the industry.

Sign Frame Finishes

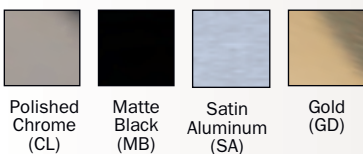

Polished Chrome (CL) Matte Black (MB) Satin Aluminum (SA) Gold (GD)

SIGN FRAMES

Model No.	Horizontal Dimension	Vertical Dimension
50-1130H	11 Inches	7 Inches
50-1130V	7 Inches	11 Inches
50-1131H	14 Inches	11 Inches
50-1131V	11 Inches	14 Inches
50-1134V	14 Inches	22 Inches
50-1136V	22 Inches	28 Inches

Traditional Post Signage

Sign frames can accommodate an array of media options ranging from changeable letters to standard poster inserts. Sign frames are available in complementary finishes to match posts.

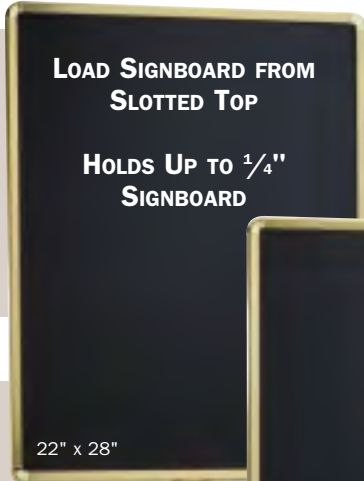

22" x 28"



14" x 22"

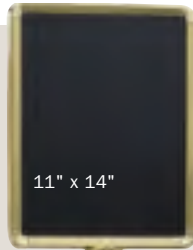

11" x 14"

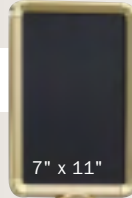

7" x 11"



7" x 11"



12" x 15"



1100SB CHANGEABLE LETTER SIGN BOARD

Grooved black panel allows for simple arrangement of 3/4" white plastic letters. Each changeable letter board comes with an assortment of 300 letters. Frames available in Brass and Chrome finishes.

MODEL 4201/22

COMPLETE SIGN STAND

22" x 28" vertical only.
60 1/2" Height

MODEL 4201/14

COMPLETE SIGN STAND

14" x 22" vertical only.
60 1/2" Height

MODEL 4201/11

COMPLETE SIGN STAND

11" x 14" vertical / horizontal frame
52 1/2" Height

4201/7 FRAME

COMPLETE SIGN STAND

7" x 11" vertical / horizontal frame
49 1/2" Height

1111 FRAME

(SHOWN WITH MODEL 2110 POST)

7" x 11" vertical / horizontal clip
48 1/2" Height

MODEL 4300/SB

COMPLETE SIGN STAND

12" x 15" vertical frame only.
53 1/2" Height

Traditional Sign Stand Finishes



Polished Chrome (10)

Satin Stainless Steel (44)

Polished Stainless Steel (40)

Polished Brass (00)



Polished Brass Clear Coat (02)



Lido-Tone® (26)

All Lido-Tone® posts will include a Matte Black(MB) sign frame.

When ordering posts please specify base option.

Base Options



4201

Flat Base, 12" Dia.
Not available in Lido-Tone®.



4202

Dome Base, 11" Dia.



4300

Slope Base, 14" Dia.

Light Duty Sign Frames

These attractively priced frames serve your signage needs when less customer traffic is anticipated.

When radius corners are desirable, please see Sign Frames on page 24.



PART NUMBER	MEDIA SIZE
10-1150	5-1/2" x 7"
10-1151	7" x 11"
10-1152	11" x 14"









Signage Inserts

With our rapid in-house sign making capabilities, your custom message or graphics are just a phone call away. Here's just some of our most requested messages.

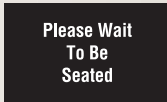
Sign frames and panels provide an easy means of communicating with your customers.

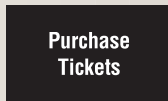
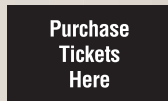
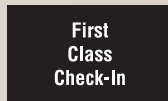

 SP01	 SP02	 SP03	 SP04	 SP05	 SP06	 SP07	 SP08
 SP09	 SP10	 SP11	 SP12	 SP13	 SP14	 SP15	 SP16
 SP17	 SP18	 SP19	 SP20	 SP21	 SP22	 SP23	 SP24
 SP25	 SP26	 SP27	 SP28	 SP29	 SP30		

Post Transporter



16 CART
16-POST TRANSPORTER

Even fully loaded, our 16-post transporter moves with ease. It's rugged design includes non-marking bumpers and non-marking gray heavy-duty wheels as standard features. 30" W x 54" L x 57" H

Baggage Sizer and Outdoor Barricade



10-BG100
BAGGAGE SIZER

Used at flight check-in to verify that luggage fits within the size constraints for a carry-on.



20-5000F/79 OR /103
OUTDOOR BARRICADE

Outdoor barricades are always needed in areas such as parking lots and near ticket lines. Lavi offers durable barricades that can easily withstand the natural element. Available in 6' or 8' lengths and 45" high.

Directrac® Sign Stands

Changing media, posters or signs, takes only seconds with Directrac's removable inner cartridge which easily slides out from the frame's side door. The light-weight, removable cartridge is available in a variety of options, including changeable letters, strip channels and a poster-holder which attaches posters and signs on both sides with a spring-loaded clip mount.

Directrac® is available in both free-standing or wall-mountable versions with a variety of finishes to fit any décor. Standard size is 22"x 28". Other sizes can be accommodated.

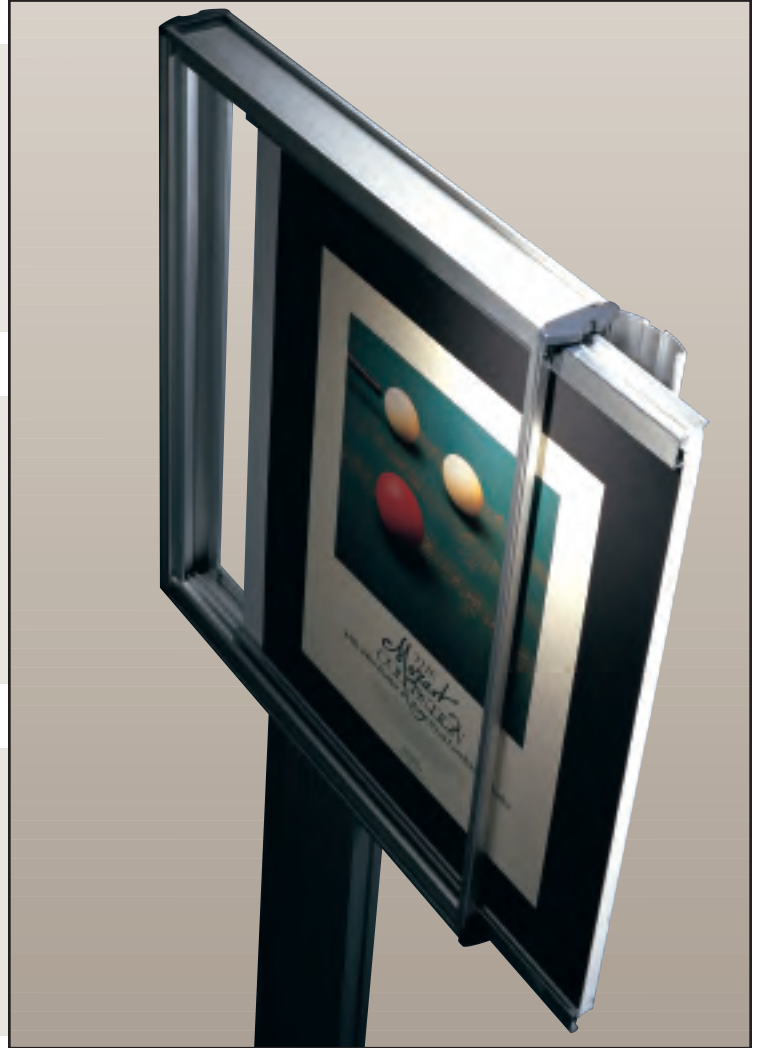

US Patent No. 5,987,794. Directrac is a registered trademark of Lavi Industries.

Directrac Sign Stand integrates changeable cartridges in a variety of media



POSTER DISPLAY CARTRIDGE

Our poster display cartridge utilizes spring-loaded clip mounts to securely hold posters in place with ease. Available with any media on reverse side.



CHANGEABLE LETTER CARTRIDGE

The changeable letter cartridge is perfect for continual change in messaging with its grooved panel and plastic letters. Available with poster display board on reverse side.



STRIP CHANNEL CARTRIDGE

With the strip-channel cartridge you have simple directional messaging. Available with poster display board on reverse side.

Directrac® Sign Stands and Wall Mounts

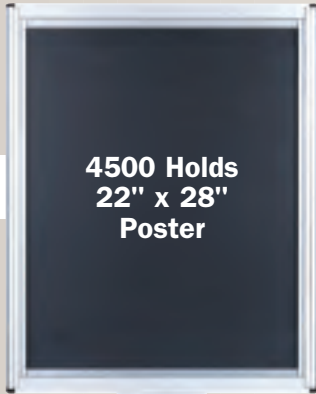

4500 Holds
22" x 28"
Poster



50-4501SA
Directrac® Sign Stand
Shown in Satin Aluminum with
Curved Base.



4520 Holds
24" x 36"
Poster



50-4520WB
Directrac® Sign Stand
Shown in Lido-Tone® Wrinkle
Black with Standard Base.

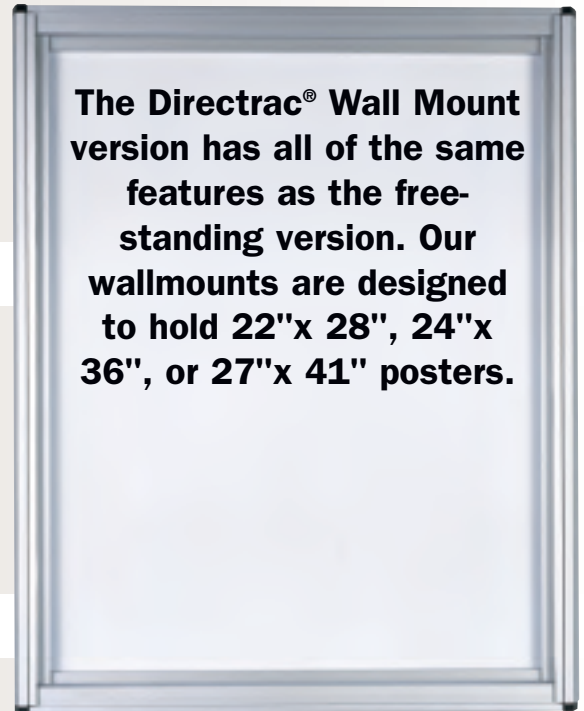

The Directrac® Wall Mount version has all of the same features as the free-standing version. Our wallmounts are designed to hold 22"x 28", 24"x 36", or 27"x 41" posters.

DIRECTRAC® WALL MOUNT

All of Directrac's features for wall mounted applications.

MODEL NO.	HORIZONTAL DIMENSION	VERTICAL DIMENSION
4510	22 Inches	28 Inches
4510H	28 Inches	22 Inches
4512	24 Inches	36 Inches
4512H	36 Inches	24 Inches
4514	27 Inches	41 Inches

4500 SERIES

Base 16-1/4" W x 23-1/2" L x 2-1/2" H
Overall Height 62-1/2"
Poster Frame 24-1/4" W x 30-1/4" H x 3" D
Holds 22" x 28" Poster

4520 SERIES

Base 16-1/4" W x 23-1/2" L x 2-1/2" H
Overall Height 67-1/2"
Poster Frame 26-1/4" W x 38-1/4" H x 3" D
Holds 24" x 36" Poster

925 BROCHURE HOLDER

Available in Matte Black (MB).

Base Options

(Please specify when ordering)

STANDARD "H" BASE

Also available in a weighted base.

STANDARD "H" BASE WITH WHEELS

CURVED BASE



Directrac® BackLit Post and Kiosk



4505
DIRECTRAC® BACKLIT POST
 Backlit for vibrant display.
 23-³/₈" W x 16-¹/₄" D x 62-¹/₂" H





4533
DIRECTRAC® KIOSK
 The Directrac Kiosk is 3-sided for 360 degree viewing. Incorporates all the unrivaled features of Directrac.
 26-¹/₂" W x 26-¹/₂" D x 68" H





Directrac® Overview

DIRECTRAC®	4500	4520
Frame Size	22" x 28"	24" x 36"
Total Height	62- ¹ / ₂ "	67- ¹ / ₂ "
Weight	57 lbs	61 lbs
Frame Material	Anodized Aluminum	Anodized Aluminum
Base Option	"H" or Curved-Cast	"H" or Curved-Cast
Locking Hinge	Yes	Yes
"H" Base Dimensions	23- ³ / ₈ " W 16- ¹ / ₄ " D	23- ³ / ₈ " W 16- ¹ / ₄ " D
Curved-Cast Base Dimensions	23- ¹ / ₂ " W 16- ¹ / ₂ " D	23- ¹ / ₂ " W 16- ¹ / ₂ " D
Base Wheels	Option	Option
Weighted Base	Option	Option
Brochure Holder	Option	Option
Un-assembled Shipping	With "H" Base	With "H" Base

STANDARD FINISH OPTIONS FOR FRAME & BASE

STAND FINISHES	CURVED-CAST BASE	"H" BASE
Wrinkle Black (WB) 	Wrinkle Black (WB)	Wrinkle Black (WB)
Gold Anodized (GD) 	Wrinkle Black (WB)	Gold Lido-Tone (LT)
Satin Al Anodized (SA) 	Wrinkle Charcoal (WC)	Wrinkle Charcoal (WC)

CUSTOM FINISH OPTIONS FOR FRAME & BASE

STAND FINISHES	CURVED-CAST BASE	"H" BASE
Gloss Black (GB)	N/A	Gloss Black (GB)
Wrinkle Charcoal (WC)	Wrinkle Charcoal (WC)	Wrinkle Charcoal (WC)
Hunter Green (HG) 	Wrinkle Black (WB)	Hunter Green (HG)
Verdi Gris (VG) 	Wrinkle Black (WB)	Verdi Gris (VG)
Pacific Sand (PS) 	Wrinkle Black (WB)	Pacific Sand (PS)
Wheel White(WW) 	Wrinkle Charcoal (WC)	Wheel White (WW)

 **Fast Ship** – does not require a minimum quantity order and are usually available for immediate delivery  **Minimum Price and Quantity required** – contact Lavi for additional information

Poster Display Sign Stands

Let your message be heard loud and clear with our value line of sign frames. They are built to last and simple to use. Available in single and double displays for 22" x 28" signs and holds up to 1/4" signboard.

All sign frames have top loading media.



2201 SINGLE SIGN DISPLAY

Single Sign Stand Display with hollow base. Available in Chrome(10) and Matte Black(MB) 56" H x 24" W x 15" D

4203/22VS SINGLE SIGN DISPLAY WITH 15" SOLID BASE

Single Sign Stand Display with 15" x 20" solid base. Available in Chrome(10) finish. 60" H x 22-1/4" W x 15" D

808916 OPTIONAL BASKET

Fits all poster displays. 13-3/8" L x 5" W x 7" H

Poster Display Sign Stands Finishes



Polished Chrome (10)



Matte Black (MB)



2202 DOUBLE SIGN DISPLAY

Double Sign Stand Display with hollow base. Available in Chrome(10) and Matte Black(MB). 59" H x 24" W x 15" D

Easel Finishes



Satin Aluminum (SA)



Matte Black (MB)

FLOOR EASEL

This freestanding easel is great for attracting your customers as they pass by or as they enter. Available in Satin Aluminum(SA) and Matte Black(MB) finishes.

50-4556 - 22" x 28" Media Size

50-4557 - 24" x 36" Media Size

Easels



4540 THRU 4548 1-1/4" MITRE CORNER QUICKCLIP™ POSTER FRAME

Quick Clip™

The versatile QuickClip™ wall mounted poster frame utilizes four hinged sides that simply flip open and close in a snap. The slim profile design with concealed mounting comes with clear poster overlay. No lamination of paper poster is required!

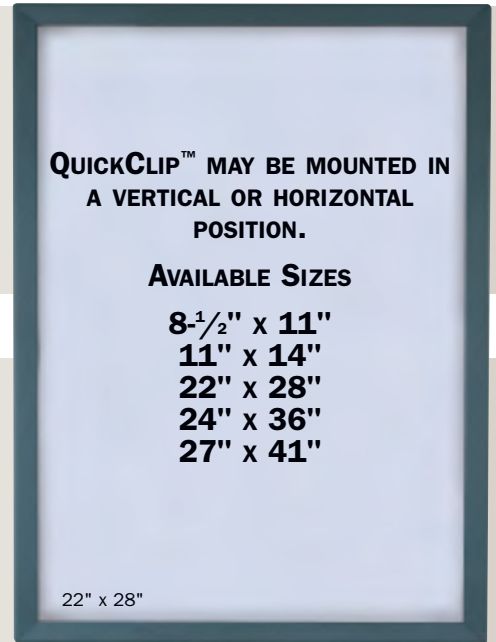

All sides of the frame simply flip open. Insert your poster. Place the clear protective overlay on top. Flip each side closed. That's it.

QuickClip™ Mitre Corner Finishes



**4640 - 4642
1" RADIUS
CORNER
QUICKCLIP™
POSTER FRAMES**

**4651 - 4654
1 1/4" RADIUS
CORNER
QUICKCLIP™
POSTER FRAMES**

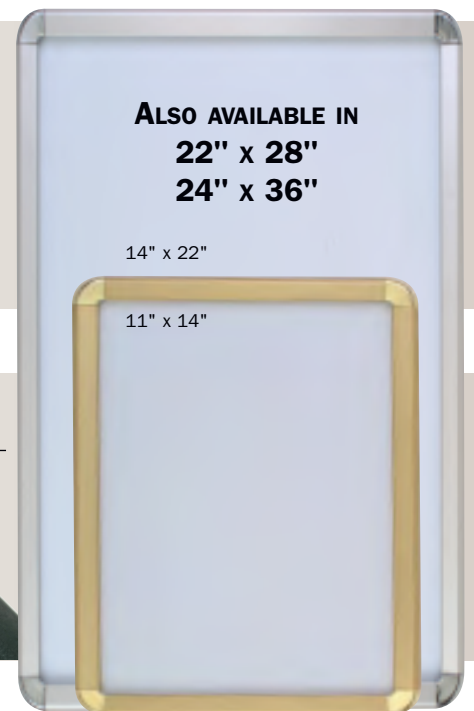

QuickClip™ Radius Corner Finishes



NeXtrac™ In-Line Retail System



As a result of listening to our customers, we called upon our expertise in public guidance to blend the category concept with merchandising and retail design. Lavi Industries proudly offers NeXtrac™, the in-line retail system for impulse sales.

The NeXtrac™ retail system is based on our Beltrac posts and is compatible with most major merchandising hardware systems, practically eliminating the need to purchase additional components. The system's flexibility, ease of configuring, rugged construction and low maintenance enhance cost effectiveness. We designed NeXtrac™ in cooperation with retail fixture specialists to better serve your needs.

Let NeXtrac™ transform your queuing floor space into a virtual store!



Surfaces & Merchandisers



In-line Tables



Trays



Rigid Rails



Branding Opportunities



Signage

How Does It Work?

The dovetail grooves in our Beltrac® 3000 posts are the key to creating a NeXtrac™ system. These grooves provide easy assembly when adding a panel, table, rail, display tray or signage.



With a simple twist of the wrist, the connectors are tightened into the dovetail groove of a Beltrac post.



50-GCA200 / 50-GCA400 **ADJUSTABLE CONNECTORS**

Adjustable grip connectors allow for easy assembly when connecting a panel, frame or wire grid to any Beltrac® 3000 post. We offer both a standard 2" grip connector and a 2" hinge grip connector which allows for flexibility when setting up your display. These are available in Satin Aluminum(C) or Matte Black(MB) Anodized finishes.



50-GCA200
Hinge Connector
Shown in Satin Aluminum.



50-GCA200/2
Grip Connector
Shown in Matte Black.



50-RRA100
Rigid Rail Assembly
Shown in Satin Aluminum,
with 2 Hinge Connectors.

50-3000SA
Beltrac® 3000
Shown in Satin Aluminum.

Rigid Rails

Rigid Rails provide a structural option for your public guidance needs. These rails allow for easy merchandising and are designed with flexibility in mind.

Not only do the rails give your queuing line a unique appearance, they allow you the freedom to hang merchandise, literature holders and shelves directly onto the rails.

All NeXtrac™ components work with our Beltrac® 3000 Posts.



FLEXIBILITY

The special hinge connectors on our Rigid Rails were designed to allow for 90 degree angles.



807236 6" Hooks

Simply place hooks onto the Rigid Rails to display your merchandise.

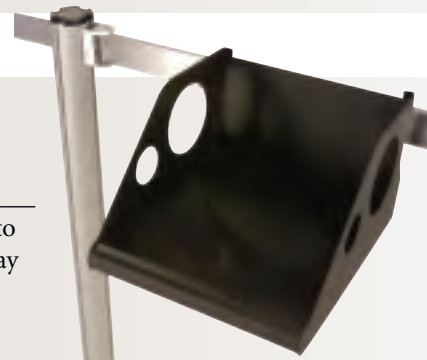

20-AC100 SHELF

Add shelves to your queuing line for additional merchandising opportunities. 12" x 12" Available in Lido-Tone® Finishes.



SIGNAGE

Add signage for branding or other messaging purposes.



50-CRA100/4 CURVED RIGID RAILS

For a contemporary look utilize our curved Rigid Rails to enhance your queuing line.

Surfaces and Merchandisers



50-SWFA105
FRAMED SLAT WALL PANEL

A double sided 47" x 36" framed aluminum slat wall panel with grip connectors that quickly and easily attaches to any Beltrac® 3000 post. This product is light weight, waterproof and easy to clean. The slat wall is currently available in Satin Aluminum finish with matching Satin Aluminum(C) frame or Wrinkle Black(WB) frame. (Custom sizes available upon request.)

50-NX100
FRAMED WIRE GRID PANEL

A double sided 48" x 30-1/2" framed wire grid panel with grip connectors that quickly and easily attaches to any Beltrac® 3000 post. The wire grid accommodates most standard hook and shelving accessories. The wire grid is currently available in Gray(GY) or Matte Black(MB) finishes with matching frames.



50-4612
QUICKCLIP™ FRAME PANEL

You can quickly and easily create exciting new imagery with our Quickclip Poster Frame. The 47" x 35" frame consists of four hinged sides that simply flip open to allow for graphics to be easily inserted. The frame with our grip connectors which are included, is double-sided for graphics on both sides of your queuing line. The QuickClip™ Panel is currently available in Satin Aluminum(SA) or Wrinkle Black(WB) finishes.



50-BTA107/4
IN-LINE TABLE

Lavi Industries offers an In-Line Table that is sturdy and elegantly designed. By providing a writing surface, your customers can easily complete necessary paperwork before they reach the counter, which will increase customer flow. In-Line Tables are shipped assembled with connectors that easily attach to any Beltrac® 3000 posts. The tables are 12" x 47-3/4" and offered in Dark Gray(DG) and Birchwood(BW) finishes.



50-BTA106

With optional pen holder.

Surfaces and Merchandisers

50-NX102

SLAT WALL GRID PANEL

This 4' x 4' slat wall grid panel attaches to any Beltrac® 3000 post with our grip connectors which are included. The wire grid is currently available in Satin Aluminum(C) or Matte Black(MB) finishes.



As Shown: with In-Line Table use part number 50-FP300S/4B.

FRAMED PANEL

The framed panel which includes our grip connectors, is an excellent method to display advertisements, logos and other messaging. Let our in-house art department produce your posters! Inserts available in clear or colored acrylic and vinyl coated foam core. Please see Page 23 under Post and Panel System for frame sizes.



BASKETS

Shown in Matte Black.

- B1 – 808050 – Polished Chrome, 6"H x 12"W x 6"D
- B1 – 809040 – Matte Black, 6"H x 12"W x 6"D
- B2 – 808681 – Polished Chrome, 4"H x 24"W x 12"D
- B2 – 806772 – Matte Black, 4"H x 24"W x 12"D

HOOKS

Shown in Matte Black.

- H1 – 806773 – 8" Matte Black Scan Tag Hook
- H2 – 807235 – 6" Matte Black Single Hook

DISPLAY TRAYS

Tray Shelves are an elegant and contemporary method of displaying merchandise on a Beltrac® 3000 post. The trays are 1/2" clear acrylic and are ready to install with the bracket and Grip Connector. Brackets are available in all Lido-Tone® Finishes.

- 80-PA101/CL – Full Round Tray, 13-1/2" Diameter
- 80-PA102/CL – Half Round Tray, 8-1/2" W x 10-1/4" D
- 80-PA103/CL – Quarter Round Tray, 18-1/2"W x 12-7/8"D



Banners and Signs

50-BRA100/C/PR BANNER ARM ASSEMBLY

Our adjustable Banner Arm Assembly can be attached to any Beltrac® 3000 post to display your banner or flag assembly. They are sold in pairs and are available in Satin Aluminum(C) finish. Banners sold separately.

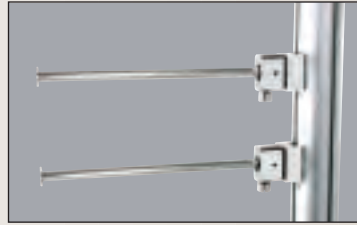

50-1138H STREET SIGN FRAME

Grab your customer's attention by using Street Signs. Street Signs easily attach to a post by attaching the grip connector into the dovetail groove on a Beltrac® 3000 post. They are 5" x 23" and are shipped assembled with two 1/8" clear acrylic panels. These signs are doubled faced allowing you to display media on both sides of the sign. Graphics are sold separately.

FA100 VERTICAL SIGN CLIPS

Vertical Sign Clips allow you the freedom to position a sign to any desired height on a Beltrac® 3000 post. These clips are designed to hold 3/8" acrylic panels in standard sizes of 3 1/2" x 5 1/2" and 7" x 11". Select any combination of connector and clip; Grip Connectors – Satin Aluminum(SA) or Matte Black(MB), Sign Clips – Polished Stainless Steel (40) or Satin Stainless Steel (44). Acrylic panels and artwork sold separately.



RIGID RAIL SIGNAGE

These framed signs are available in custom sizes and mount onto the Rigid Rail Assembly. Graphics sold separately.

Materials:

Lavi Industries utilizes premium materials for architectural interiors. Our products are designed to meet most building codes.

Solid brass and stainless steel are our choice materials for quality and durability. We finish these metals in-house, to maintain rigid quality control.

Warranty

Our products carry a limited warranty against defects and failure. Please refer to our current Price List for warranty details.

Ordering Information

1. Part Numbers and Finish Designation

When ordering, please use finish prefix as specified in the Materials and Finishes chart below.

Example:

10-2010 = **Polished Chrome** Regal Traditional Post.

40-41200 = **Polished Stainless Steel**
Beltrac Infinity¹²™ Post.

50-4500GD = **Bright Anodized Aluminum**
Gold Directrac® Post.

2. Drawings

Our engineering department will be happy to assist you with your specification requirements. Drawings of our products are available as needed. We can generate CAD drawings for your specific job, please consult us for details.

Lido-Tone®

Lido-Tone powder coating is highly durable, as well as decorative. This two coat finish combines the outstanding chemical and mechanical properties of epoxies with a wide variety of colors and surface textures. When an exterior application is specified, a polyester-based coating will be utilized. See Lido-Tone standard color chart below. Custom colors and finishes are available. Please consult with your Sales Executive.

Lido-Tone Textured Finishes



Lido-Tone Wet-Look Finishes



Materials and Finishes

FINISH	MATERIAL	PREFIX	MAINTENANCE
Mill Brass	Solid Brass	01	Not Applicable.
Polished Brass		00	Lido-Lustre™, or other brass polish.
Polished Brass, Clear Coat		02	Damp rag, avoid ammonia base cleaners.
Satin Brass, Clear Coat		04	
Mill Stainless Steel	Stainless Steel, Alloy 304	41	Not Applicable.
Polished #7 Stainless Steel		40	Maintenance free or Lido-Lustre™.
Satin #4 Stainless Steel		44	Maintenance free.
Polished Chrome	Solid Brass (Fittings)	10	Damp rag, avoid ammonia base cleaners.
	Solid Brass (Tubing)	12	
	Carbon Steel (Tubing)	10	
Lido-Tone	Solid Brass	06	
	Carbon Steel	26	
	Aluminum, Alloy 6061	56	
Bright Anodized	Aluminum, Alloy 6063	50	



LB-00202

Lido-Lustre™ Metal Polish Cream should be used to repolish uncoated brass, aluminum and stainless steel. Available in 6.33 oz. tubes and 16 oz. jars.